

Cable & Wiring Accessories

Rail Mount Terminals & DIN Rail

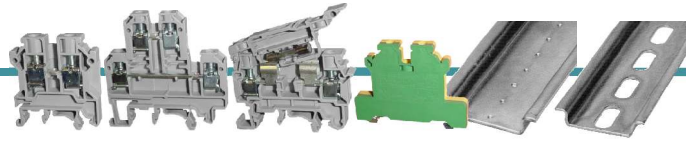

Page 12.2

Busbar & Busbar Terminals

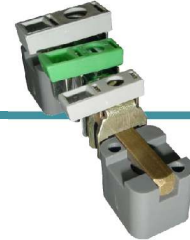

Page 12.4

Cable Ties & Mounting Cradles

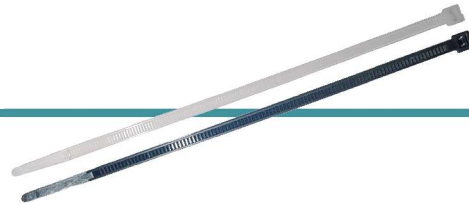

Page 12.4

P.V.C. Slotted Trunking

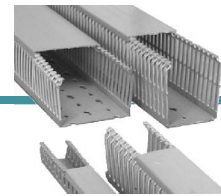

Page 12.5

Crimping Lugs & Ferrules

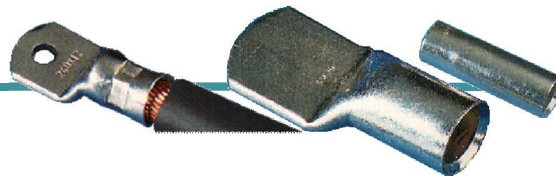

Page 12.6

Pre-insulated, Fully Insulated
& Un-insulated Terminals



Page 12.8

All Prices Exclude VAT and are subject to change without prior notice.

RAIL MOUNT TERMINALS

Mountings: DIN 35 "Top Hat" rail
 Max. Working temp: 100°C
 Rated Voltage: 750v VDE
 Material: Insulated body polyamide 6.6
 Nickel-plated copper Alloy busbars
 Zinc plated and chromate passivated clamping arms and screws

STANDARD TERMINALS

Colour - Grey

PART NO	TERMINAL / WIRE SIZE (mm ²)	WIDTH (mm ²)	AMPS	TERMINAL MARKER	Price
CTS4UN	4.0	6.0	32 A	CA509/K6	9.00
CTS6U	6.0	8.0	41 A	CA509/K8	11.80
CTS10U	10.0	10.0	57 A	CA509/K10	15.70
CTS25UN - No end plate required	16.0 - 25.0	12.0	101 A	CA509/K12	37.00
CTS35UN - No end plate required	35.0	15.0	125 A	CA509/K15	60.40
CTS50U	50.0	20.5	150 A	CA509/K2	172.00
CTS95U	95.0	25.0	232 A	CA509/K2	242.80

2 STAGE TERMINAL (Double Tier)

PART NO	TERMINAL / WIRE SIZE (mm ²)	WIDTH (mm ²)	AMPS	TERMINAL MARKER	Price
CDL4UN	4.0	6.0	32 A	CA509/K2	25.30

FUSED TERMINALS

Colour - Grey

PART NO	WIRE SIZE (mm ²)	WIDTH (mm ²)	FUSES	TERMINAL MARKER	Price
CF4U - No end plate required	4.0	8.0	5x20 or 5x25	CA509/K8	49.70

END PLATES

PART NO	TERMINAL SIZE	Price
EP2.5/4UN	for 4.0 mm terminals	4.40
EP6/10U	for 6.0 mm & 10.0 mm terminals	4.90
EPCDL4UN	for 4.0 mm 2 stage terminals	9.70

PARTITIONS

PART NO	TERMINAL SIZE	Price
PP2.5/4UN	for 4.0 mm terminals	8.30
PP6/10U	for 6.0 mm & 10.0mm terminals	10.30

COMB LINK / BRIDGING BAR

PART NO	TERMINAL / WIRE SIZE (mm ²)	Description	Price
CA713/10	4.0	10 WAY Comb Link	50.40

Continued on next page....

All Prices Exclude VAT and are subject to change without prior notice.

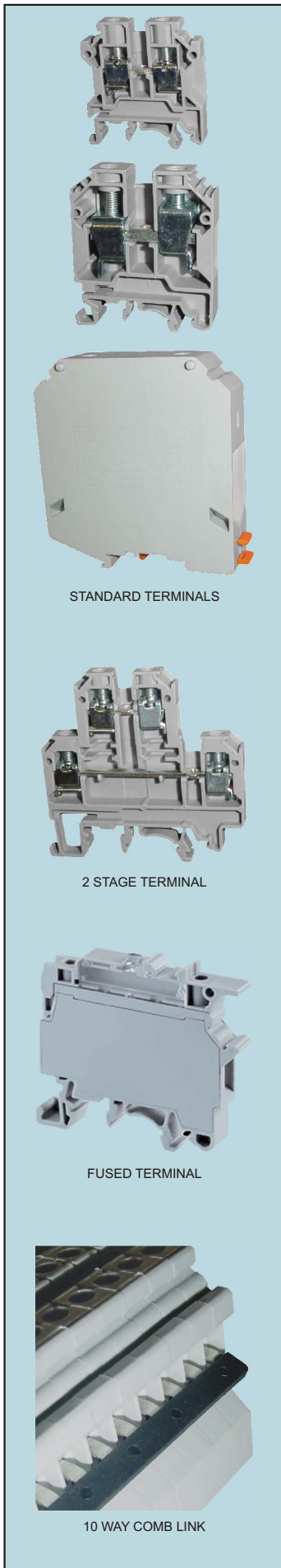

STANDARD TERMINALS

2 STAGE TERMINAL

FUSED TERMINAL

10 WAY COMB LINK

RAIL MOUNT TERMINALS

Mountings: DIN 35 "Top Hat" rail
 Max. Working temp: 100°C
 Rated Voltage: 750v VDE
 Material: Insulated body polyamide 6.6
 Nickel-plated copper Alloy busbars
 Zinc plated and chromate passivated clamping arms and screws

EARTH TERMINALS

Colour - Yellow & Green



EARTH TERMINALS

PART NO	TERMINAL / WIRE SIZE (mm ²)	AMPS	TERMINAL MARKER	Price
CGT4N	4.0	32 A	CA509/K6	44.00
CGT10U	10.0	57 A	CA509/K10	60.30
CGT35U	35.0	125 A	CA509/K15	138.50

END CLAMP



END CLAMP

PART NO	TERMINAL MARKER	Price
CA802	CA509/K8	8.00

DISTRIBUTION BLOCKS

Colour - Grey

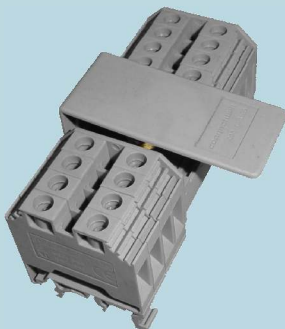

DISTRIBUTION BLOCK

PART NO	Wire (mm ²)	INPUT Amps	Stud	OUTPUT TERMINAL	TERMINAL MARKER	Price
CDB4/5	16.0	50 A	5mm	4mm - CTS4UN	CA509/K6	196.40
CDB6/4	25.0	95 A	6mm	6mm - CTS6U	CA509/K8	187.50
CDB10/4	35.0	125 A	10mm	10mm - CTS10U	CA509/K10	228.80

•Note:

- Sum of outgoing currents on either side of centre should not exceed half the maximum permissible incoming current.
- Sum of total outgoing currents should not exceed maximum permissible incoming current.
- Connection for higher outgoing currents should be done through the terminal nearer to incoming connection at centre.

TERMINAL MARKERS

CA509/K2 Individual Strips: Numeric numbers "0" thru "9"
 Alphabetic letters "A" thru "Z"
 Miscellaneous "+" & "-"

CA509/K6 Individual Strips: Numeric numbers "0" thru "20"
 Alphabetic letters "A" thru "Z"
 Miscellaneous "+" & "-"

Sequential Strips: "1 to 10", "11 to 20", "21 to 30", "31 to 40", "41 to 50",
 "51 to 60", "61 to 70", "71 to 80", "81 to 90" & "91 to 100"

Note: All markers are sold per strip, each consisting of 10 markers
 Special markers can be made up on request.

PART NO	Individual Strips	Sequential Strips	Blank Strips	Terminal use	Price
CA509/K2-*	✓	-	✓	CDL4U & CSLFU	48.80
CA509/K6-*	✓	✓	✓	All except CDL4U	48.80
CA509/K8-*	-	-	✓	CTS6U	49.50
CA509/K10-*	-	-	✓	CTS10U	49.50
CA509/K12-*	-	-	✓	CTS25U	56.40
CA509/K15-*	-	-	✓	CTS35U	56.40

Note: Replace * with character or sequence required.

TOP HAT RAIL

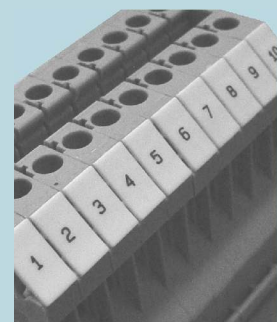

TERMINAL MARKERS

PART NO	DESCRIPTION	UNIT	Price
AMC35U	DIN-35 plain Top Hat rail	per 2m length	80.50
AMC35US	DIN-35 slotted Top Hat rail	per 2m length	80.50

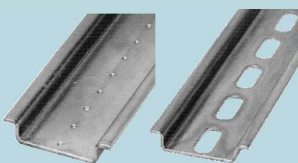

PLAIN & SLOTTED TOP HAT RAIL

All Prices Exclude VAT and are subject to change without prior notice.

BUSBAR & ACCESSORIES

Approvals: CSA, VDE & UL; SABS Auth RCC 0303029

BUSBAR

PARTNO	DESCRIPTION	Price
BBCOPP	6 mm x 6mm copper	138.00

BUSBAR TERMINALS

Fitted with a wire clamp.

PARTNO	WIRE SIZE (MM ²)	Price
CENC4	4	5.20
CENC16	16/25	8.60
CENC35	35	15.50

BUSBAR SUPPORTS

PARTNO	BUSBAR SIZE	DIMENSION W D H	Price
BB6SUPP	6 x 6 mm	24 20 18	2.30

CABLE TIES & MOUNTING CRADLES

PARTNO	DIMENSION		COLOUR	Price
	L	W		
<u>CABLE TIES</u>				
T18RB	104 mm	2.5 mm	Black	17.80
T18RW	104 mm	2.5 mm	White	18.50
T30RB	150 mm	3.5 mm	Black	35.50
T30RW	150 mm	3.5 mm	White	37.80
T50RB	205 mm	4.7 mm	Black	53.90
T50RW	205 mm	4.7 mm	White	60.60
T50IB	305 mm	4.7 mm	Black	93.30
T50IW	305 mm	4.7 mm	White	90.90
T50LB	395 mm	4.7 mm	Black	108.90
T50LW	395 mm	4.7 mm	White	121.70
T120RB	395 mm	7.8 mm	Black	240.00
T120RW	395 mm	7.8 mm	White	249.30
LK5B	543 mm	13.0 mm	Black	815.80
T120SB	280 mm	7.8 mm	Black	186.20

MOUNTING CRADLES

TY3-GISB	20 mm	15 mm	Black	167.80
TY3-GISW	20 mm	15 mm	White	176.10
TY8-GISB	33 mm	25 mm	Black	390.00
TY8-GISW	33 mm	25 mm	White	400.80

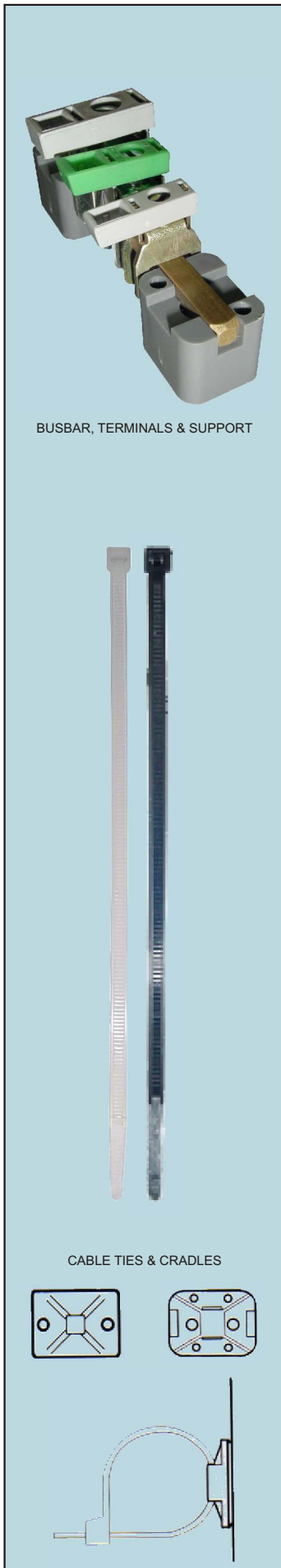

All Prices Exclude VAT and are subject to change without prior notice.

P.V.C. SLOTTED TRUNKING

TRUNKING

Material: Self extinguishing hard P.V.C.
 Colour: RAL 7030
 Length: 2 meters

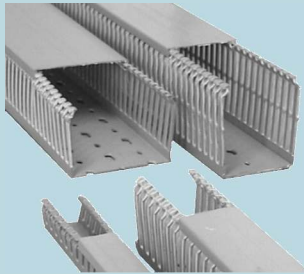

SLOTTED TRUNKING



CLIP-ON SUPPORT

PARTNO	DIMENSION		Price
	W	H	
2525N	25	25	65.20
2540N	25	40	84.80
4040N	40	40	101.80
6040N	60	40	127.00
8040N	80	40	176.50
2560N	25	60	113.20
4060N	40	60	124.20
6060N	60	60	175.80
8060N	80	60	207.00
10060N	100	60	312.80
4080N	40	80	138.00
6080N	60	80	265.00
8080N	80	80	324.00
10080N	100	80	331.40
12080N	120	80	651.40
80100N	80	100	384.70
100100N	100	100	579.60
SPARE COVERS			
COV25	25		33.10
COV40	40		49.70
COV60	60		80.00
COV80	80		96.60

ACCESSORIES

PARTNO	DESCRIPTION	Price
STSUPP	Clip-on support for fitting slotted trunking and pushbuttons to door panels.	17.90

All Prices Exclude VAT and are subject to change without prior notice.

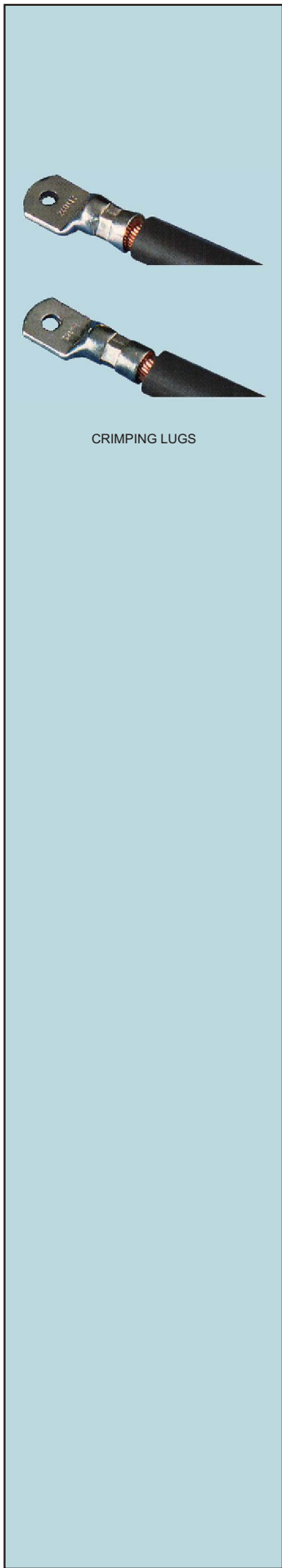

CRIMPING LUGS

PARTNO	CABLE SIZE (mm ²)	STUD SIZE (mm)	Price
L1-4	1.5	4	138.50
L1-5	1.5	5	138.50
L1-6	1.5	6	153.10
L2-4	2.5	4	144.60
L2-5	2.5	5	145.80
L2-6	2.5	6	150.70
L2-8	2.5	8	447.00
L4-4	4.0	4	194.40
L4-5	4.0	5	182.20
L4-6	4.0	6	195.60
L4-8	4.0	8	496.70
L4-10	4.0	10	542.90
L6-4	6.0	4	238.10
L6-5	6.0	5	218.60
L6-6	6.0	6	235.60
L6-8	6.0	8	563.50
L6-10	6.0	10	610.90
L10-5	10.0	5	386.30
L10-6	10.0	6	413.00
L10-8	10.0	8	484.60
L10-10	10.0	10	664.40
L10-12	10.0	12	1253.30
L16-6	16.0	6	501.60
L16-8	16.0	8	545.30
L16-10	16.0	10	592.70
L16-12	16.0	12	838.00
L25-6	25.0	6	844.10
L25-8	25.0	8	835.60
L25-10	25.0	10	879.30
L25-12	25.0	12	1042.00
L35-6	35.0	6	1168.30
L35-8	35.0	8	1168.30
L35-10	35.0	10	1168.30
L35-12	35.0	12	1341.90
L35-16	35.0	16	1640.70
L50-6	50.0	6	1587.20
L50-8	50.0	8	1544.80
L50-10	50.0	10	1617.60
L50-12	50.0	12	1892.10
L50-16	50.0	16	2209.00
L70-8	70.0	8	2606.10
L70-10	70.0	10	2606.10
L70-12	70.0	12	2638.90
L70-16	70.0	16	3198.80
L95-8	95.0	8	4010.10
L95-10	95.0	10	4010.10
L95-12	95.0	12	4010.10
L95-16	95.0	16	4280.80
L95-20	95.0	20	6039.20

Continued on next page....

All Prices Exclude VAT and are subject to change without prior notice.



CRIMPING LUGS

PARTNO	CABLE SIZE (mm ²)	STUD SIZE (mm)	Price
L120-10	120.0	10	5463.70
L120-12	120.0	12	5463.70
L120-16	120.0	16	5808.50
L120-20	120.0	20	7424.90
L150-10	150.0	10	7961.70
L150-12	150.0	12	7961.70
L150-16	150.0	16	7961.70
L185-10	185.0	10	10546.00
L185-12	185.0	12	10546.00
L185-16	185.0	16	10546.00
L240-10	240.0	10	16197.80
L240-12	240.0	12	16197.80
L240-16	240.0	16	16197.80
L240-20	240.0	20	17208.10
L300-10	300.0	10	20279.30
L300-12	300.0	12	20279.30
L300-16	300.0	16	20279.30
L400	400.0	BLANK	31851.30
L500	500.0	BLANK	45270.40
L630	630.0	BLANK	68296.70



CRIMPING LUG



BLANK CRIMPING LUG



FERRULE

CRIMPING FERRULES

PARTNO	CABLE SIZE (mm ²)	Price
F1	1.5	124.00
F2	2.5	140.90
F4	4.0	174.90
F6	6.0	200.40
F10	10.0	329.10
F16	16.0	405.70
F25	25.0	573.30
F35	35.0	768.80
F50	50.0	1368.70
F70	70.0	1926.10
F95	95.0	3160.00
F120	120.0	4252.90
F150	150.0	6027.20
F185	185.0	8803.30
F240	240.0	12703.90
F300	300.0	19198.60

All Prices Exclude VAT and are subject to change without prior notice.

PRE-INSULATED TERMINALS

RING TERMINALS

PARTNO	COLOUR	WIRE SIZE (mm ²)	STUD SIZE (mm)	OUTER WIDTH (mm)	Price
1R10	Red	0.25 - 1.65	10.0	13.6	212.40
1R8	Red	0.25 - 1.65	8.0	11.6	168.10
1R6	Red	0.25 - 1.65	6.0	11.6	178.10
1R5	Red	0.25 - 1.65	5.0	8.0	89.60
1R4	Red	0.25 - 1.65	4.0	8.0	114.40
1R3	Red	0.25 - 1.65	3.0	5.7	89.20
2R10	Blue	1.04 - 2.63	10.0	13.6	232.90
2R8	Blue	1.04 - 2.63	8.0	12.0	223.60
2R6	Blue	1.04 - 2.63	6.0	12.0	236.30
2R5	Blue	1.04 - 2.63	5.0	9.5	148.50
2R4	Blue	1.04 - 2.63	4.0	8.5	147.10
2R35	Blue	1.04 - 2.63	3.5	8.5	127.00
3R10	Yellow	2.63 - 6.64	10.0	15.0	400.20
3R8	Yellow	2.63 - 6.64	8.0	15.0	417.90
3R6	Yellow	2.63 - 6.64	6.0	12.0	372.30
3R5	Yellow	2.63 - 6.64	5.0	9.5	283.60
3R4	Yellow	2.63 - 6.64	4.0	9.5	290.10
3R35	Yellow	2.63 - 6.64	3.5	7.2	297.70

SPADE / FORK TERMINALS

PARTNO	COLOUR	WIRE SIZE (mm ²)	STUD SIZE (mm)	OUTER WIDTH (mm)	Price
1S5A	Red	0.25 - 1.65	5.0	8.1	105.70
1S4A	Red	0.25 - 1.65	4.0	6.4	105.60
1S35	Red	0.25 - 1.65	3.0	6.4	116.80
2S5A	Blue	1.04 - 2.63	5.0	8.1	122.80
2S4A	Blue	1.04 - 2.63	4.0	6.4	122.80
2S35	Blue	1.04 - 2.63	3.5	6.0	106.80
3S6A	Yellow	2.63 - 6.64	6.0	9.0	297.00
3S5	Yellow	2.63 - 6.64	5.0	9.0	256.80
3S4A	Yellow	2.63 - 6.64	4.0	8.3	256.80

PIN TERMINALS

PARTNO	COLOUR	WIRE SIZE (mm ²)	PIN LENGTH (mm)	Price
1P10	Red	0.25 - 1.65	10.0	101.20
2P12	Blue	1.04 - 2.63	10.0	137.90
3P13	Yellow	2.63 - 6.64	13.0	275.80

HOOK BLADE TERMINALS

PARTNO	COLOUR	WIRE SIZE (mm ²)	Price
1HB	Red	0.25 - 1.65	191.00
2HB	Blue	1.04 - 2.63	205.90
3HB	Yellow	2.63 - 6.64	337.00

Continued on next page....

All Prices Exclude VAT and are subject to change without prior notice.



PRE-INSULATED TERMINALS

MALE DISCONNECT TERMINALS

PARTNO	COLOUR	WIRE SIZE (mm ²)	INSERT HEIGHT (mm)	OUTER WIDTH (mm)	Price
T1DM	Red	0.25 - 1.65	0.8	6.3	211.40
T2DM	Blue	1.04 - 2.63	0.8	6.3	211.10
T3DM	Yellow	2.63 - 6.64	0.8	6.3	352.80

FEMALE DISCONNECT TERMINALS

PARTNO	COLOUR	WIRE SIZE (mm ²)	INSERT HEIGHT (mm)	OUTER WIDTH (mm)	Price
T1DF	Red	0.25 - 1.65	0.8	7.4	238.30
T2DF	Blue	1.04 - 2.63	0.8	7.4	222.40
T3DF	Yellow	2.63 - 6.64	0.8	7.4	383.20

PIGGY BACK DISCONNECT TERMINALS

PARTNO	COLOUR	WIRE SIZE (mm ²)	INSERT HEIGHT (mm)	OUTER WIDTH (mm)	Price
T1PB	Red	0.25 - 1.65	0.8	7.4	277.60
T2PB	Blue	1.04 - 2.63	0.8	7.4	297.70

BULLET TERMINALS

PARTNO	COLOUR	WIRE SIZE (mm ²)	LENGTH (mm)	DIAMETER (mm)	Price
T1ULM	Male Red	0.25 - 1.65	16.00	4.0	208.40
T2ULM	Male Blue	1.04 - 2.63	16.00	5.0	277.60
T1ULF	Female Red	0.25 - 1.65	19.5	4.0	238.10
T2ULF	Female Blue	1.04 - 2.63	20.5	5.0	247.80

BOOTLACE FERRULES

PARTNO	COLOUR	WIRE SIZE (mm ²)	PIN LENGTH (mm)	Price
E0510WT	White	0.5	10.0	55.80
E0710BL	Blue	0.75	10.0	55.80
E1010RD	Red	1.0	10.0	57.70
E1510BK	Black	1.5	10.0	57.70
E2512GY	Grey	2.5	12.0	64.90
E4012OR	Orange	4.0	12.0	102.20
E6012GR	Green	6.0	12.0	121.80

FERRULE / BUTT CONNECTORS

PARTNO	COLOUR	WIRE SIZE (mm ²)	Price
1UT	Red	0.25 - 1.65	141.60
2UT	Blue	1.04 - 2.63	160.30
3UT	Yellow	2.63 - 6.64	260.50

FULLY INSULATED TERMINALS

PARTNO	COLOUR	WIRE SIZE (mm ²)	INSERT HEIGHT (mm)	OUTER WIDTH (mm)	Price
TF2DF	Female Blue	1.04 - 2.63	0.8	7.4	295.70

UN-INSULATED TERMINALS

DISCONNECT TERMINALS

PARTNO	WIRE SIZE (mm ²)	OUTER WIDTH (mm)	Price
LF061250A	Female side entry 0.75 - 2.00	7.6	466.20
LOM51250	Male back entry 0.50 - 2.00	6.3	303.30
LT061250N	Female back entry 0.75 - 2.00	7.6	424.60
LT081250N	Female back entry 2.00 - 3.50	7.6	374.90

Continued on next page....

All Prices Exclude VAT and are subject to change without prior notice.



PRE-INSULATED TERMINALS

PRE-PACKED TERMINALS

PRE-PACKED TERMINALS

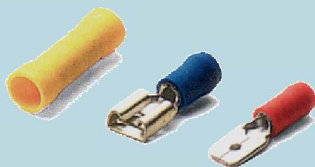

PARTNO	NO	COLOUR	WIRE SIZE (mm ²)		PACK QTY	Price
<u>RING TERMINALS</u>						
1R6BP	1	Red	0.25 - 1.65	Stud - 6.0	14	24.40
1R5BP	2	Red	0.25 - 1.65	Stud - 5.0	18	24.40
1R4BP	3	Red	0.25 - 1.65	Stud - 4.0	18	24.40
2R6BP	4	Blue	1.04 - 2.63	Stud - 6.0	12	24.40
2R5BP	5	Blue	1.04 - 2.63	Stud - 5.0	16	24.40
2R4BP	6	Blue	1.04 - 2.63	Stud - 4.0	16	24.40
3R8BP	7	Yellow	2.63 - 6.64	Stud - 8.0	7	24.40
3R6BP	8	Yellow	2.63 - 6.64	Stud - 6.0	8	24.40
3R5BP	9	Yellow	2.63 - 6.64	Stud - 5.0	10	24.40
<u>SPADE / FORK TERMINALS</u>						
1S35BP	10	Red	0.25 - 1.65	Stud - 3.0	18	24.40
1S4ABP	11	Red	0.25 - 1.65	Stud - 4.0	19	24.40
2S35BP	12	Blue	1.04 - 2.63	Stud - 3.5	16	24.40
2S5ABP	13	Blue	1.04 - 2.63	Stud - 5.0	17	24.40
<u>PIN TERMINALS</u>						
1P10BP	14	Red	0.25 - 1.65	Pin - 10.0	16	24.40
2P8BP	15	Blue	1.04 - 2.63	Pin - 10.0	15	24.40
<u>FERRULE / BUTT CONNECTORS</u>						
1UTBP	16	Red	0.25 - 1.65		16	24.40
2UTBP	17	Blue	1.04 - 2.63		15	24.40
<u>MALE DISCONNECT TERMINALS</u>						
T1DMBP	18	Red	0.25 - 1.65		14	24.40
T2DMBP	19	Blue	1.04 - 2.63		14	24.40
<u>FEMALE DISCONNECT TERMINALS</u>						
T1DFBP	20	Red	0.25 - 1.65		13	24.40
T2DFBP	21	Blue	1.04 - 2.63		13	24.40
<u>PIGGY BACK DISCONNECT TERMINALS</u>						
T1PBBP	22	Red	0.25 - 1.65		10	24.40
T2PBBP	23	Blue	1.04 - 2.63		10	24.40
<u>MALE BULLET TERMINALS</u>						
T1ULMBP	24	Red	0.25 - 1.65		13	24.40
T2ULMBP	25	Blue	1.04 - 2.63		13	24.40
<u>FEMALE BULLET TERMINALS</u>						
T1ULFBP	26	Red	0.25 - 1.65		10	24.40
T2ULFBP	27	Blue	1.04 - 2.63		10	24.40

All Prices Exclude VAT and are subject to change without prior notice.